

Handheld Ultrasonic Flowmeter User Manual



Contents

1. Introduction.....	5
§ 1.1 Preface.....	5
§ 1.2 Features.....	6
§ 1.3 Principle of Measurement	6
§ 1.4 Parts Identification.....	8
§ 1.5 Typical Applications.....	10
§ 1.6 Data Integrity and Built-in Time Keeper	11
§ 1.7 Product Identification.....	11
§ 1.8 Specifications.....	12
2. Starting Measurement	13
§ 2.1 Built-in Battery.....	13
§ 2.2 Power On.....	14
§ 2.3 Keypad	15
§ 2.4 Menu Windows.....	16
§ 2.5 Menu Windows Arrangement.....	17
§ 2.6 Steps to Configure the Parameters	18
§ 2.7 Transducers Mounting Allocation.....	19
§ 2.8 Transducers Installation	20
§ 2.8.1 Transducers Spacing.....	21
§ 2.8.2 V-method Installation.....	21
§ 2.8.3 Z-method Installation.....	21
§ 2.8.4 W-method Installation.....	22
§ 2.8.5 N-method Installation.....	22
§ 2.9 Installation Checkup.....	22
§ 2.9.1 Signal Strength.....	22
§ 2.9.2 Signal Quality.....	23
§ 2.9.3 Total Transit Time and Delta Time.....	23
§ 2.9.4 Time Ratio between the Measured Total Transit Time and the Calculated Time.....	24

3. How To.....	25
§3.1 How to judge if the instrument works properly.....	25
§3.2 How to judge the liquid flowing direction.....	25
§3.3 How to change between units systems.....	25
§3.4 How to select a required flow rate unit.....	25
§3.5 How to use the totalizer multiplier.....	26
§3.6 How to open or shut the totalizer.....	26
§3.7 How to reset the totalizer.....	26
§3.8 How to restore the flow meter with default setup.....	26
§3.9 How to use the damper.....	26
§3.10 How to use the zero-cutoff function.....	27
§3.11 How to setup a zero point.....	27
§3.12 How to get a scale factor for calibration.....	27
§3.13 How to use the operation locker.....	27
§3.14 How to use the built-in data logger.....	28
§3.15 How to use the Frequency Output... ..	28
§3.16 How to use the Totalizer Pulse Output.....	29
§3.17 How to produce an alarm signal.....	29
§3.18 How to use the built-in Buzzer.....	30
§3.19 How to use the OCT output.....	30
§3.20 How to modify the built-in calendar.....	30
§3.21 How to adjust the LCD contrast.....	31
§3.22 How to use the RS232 serial interface.....	31
§3.23 How to view the Date Totalizer	31
§3.24 How to use the Working Timer	31
§3.25 How to use the manual totalizer	31
§3.26 How to check the ESN and other minor details.....	31
§3.27 How to know how long the battery will last.....	32
§3.28 How to charge the built-in battery.....	32
4. Menu Window Details	33
5. Troubleshooting.....	38
§5.1 Power-on Error Displays and Counter-Measures	38
§5.2 Error Code and Counter-Measures	38
§5.3 Other Problems and Solutions	40

6. Communication Protocol	41
§6.0 General	41
§6.1 Interface Pin-out Definition	41
§6.2 the Protocol.....	41
§6.3 Protocol Prefix Usage	43
§6.4 Codes for the Keypad	44
7. Warranty and Service	45
§7.1 Warranty	45
§7.2 Service	45

1. Introduction

§1.1 Preface

The Series Handheld Ultrasonic Flowmeter incorporates the latest ICs manufactured from the famous semiconductor manufacturers like Philips, Maxim, TI, Winbond, and Xilinx. The hardware features the ease of operation, high accuracy and outstanding reliability, while the software provides a user friendly interface and much more functions. It employs a patent balanced lower voltage multi-pulse igniting circuit which increases the anti-interference ability magnificently so that the flow meter will work properly even in demanding industrial environments such as those with power frequency transverter working nearby.

Other outstanding features:

---the signal receiving circuits feature self-adapting performance so as to ensure that the user can easily operate the instrument without any adjustment.

---the built-in rechargeable Ni-H battery can work continuously for more than 12 hours for a single charge.

The advanced circuit design, the integration of the latest semiconductors, the user-friendly software interface both in English and Chinese languages and small-sized PCB board, all these features combine to make the series ultrasonic flow meter the best and the biggest seller on the Chinese market. Moreover, it is gaining more and more recognition on the international flow meter market as well.

§1.2 Features

- *0.5% of linearity
- * built-in date
- *totalizer ultrasonic igniting
- *Work properly in sites with strong magnetic interference.
- * 0.5 second totalizing period
- *Patent balanced lower-voltage multi-pulse
- *Bilingual interface in Chinese and English
- *100 Pico-second resolution of time measurement
- * 0.2% of repeatability
- *4 flow totalizer
- * built-in data-logger

§1.3 Principle of Measurement

The Handheld ultrasonic flow meter is designed to measure the fluid velocity of liquid within a closed conduit. The transducers are a non-contacting, clamp-on type, which will provide benefits of non-fouling operation and easy installation.

The transit time method utilizes two transducers that function as both ultrasonic transmitters and receivers. The transducers are clamped on the outside closed pipe at a specific distance from each other.

The transducers can be mounted in V-method where the sound transverses the pipe twice, or W-method where the sound transverses the pipe four times, or in Z-method where the transducers are mounted on opposite sides of the pipe and the sound crosses the pipe once.

This selection of the mounting method depends on pipe and liquid characteristics. The flow meter operates by alternately transmitting and receiving a frequency modulated burst of sound energy between the two transducers and measuring the transit time difference. The difference in the transit time measured is directly and exactly related to the velocity of the liquid in the pipe, as shown in Figure 1.

Figure 1: Transit Time Illustration

$$V = \frac{MD}{\sin 2\theta} \times \frac{\Delta T}{T_{up} \cdot T_{down}}$$

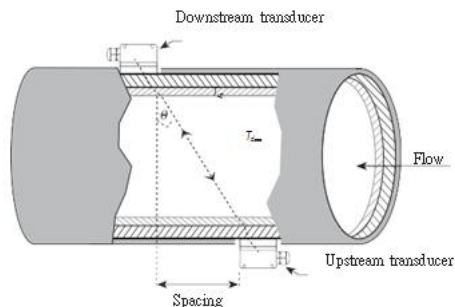

Where

θ is the include angle to the flow direction

M is the travel times of the ultrasonic beam

D is the pipe diameter

T_{up} is the time for the beam from upstream transducer to the downstream one

T_{down} is the time for the beam from downstream transducer to the upstream one

$\Delta T = T_{up} - T_{down}$

§1.4 Parts Identification Converter:

Top view

up stream transducer socket downstream transducer socket

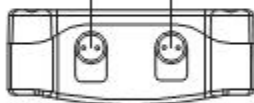

Front view



LCD DISPLAY

LED Charging Indicator

Keypad

Bottom view

Pins for battery recharge RS-232C communication interface

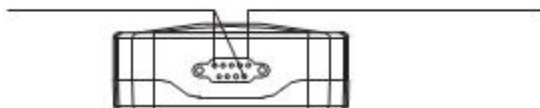

Transducers:

Standard-HM (50mm-700mm)

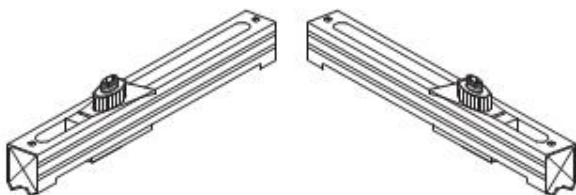

Standard-HS (20mm-100mm)
(Optional Accessories)



Cable 5m x2

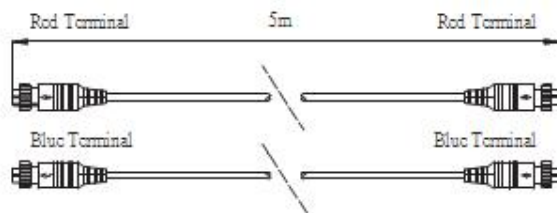

Extended Cable 5m x2 (Optional Accessories)

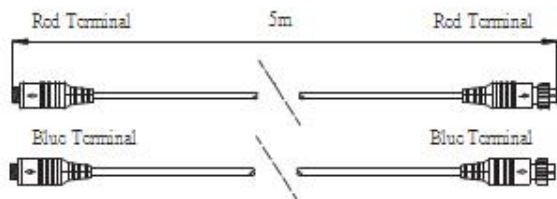

Converted Terminal and AC/DC Adapter

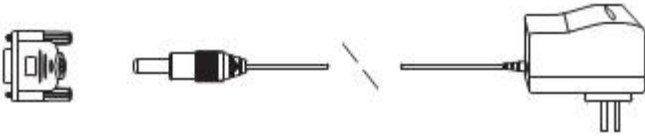

Cable of RS-232C interface

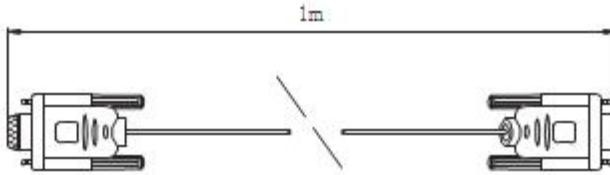

§1.5 Typical Applications

The flow meter can be applied to a wide range of measurements. The measured pipe ranges 15-6000 mm [0.5 - 200 inch]. A variety of liquid applications can be accommodated: ultra-pure liquids, potable water, chemicals, raw sewage, reclaimed water, cooling water, river water, plant effluent, etc. Because the instrument and transducers are non-contacting and have no moving parts, the flow meter will not be affected by system pressure, fouling or wear. Standard transducers are rated to 90 °C. Higher temperatures can be accommodated (Up to 160 °C). For further information, please consult the manufacturer for assistance.

§1.6 Data Integrity and Built-in Time-Keeper

All user-inputted configuration values are retained in the built-in non-volatile flash memory that can store them for over 100 years, even if power is lost or turned off. Password protection is provided to avoid inadvertent configuration changes or totalizer resets.

A time-keeper is integrated in the flow meter for the index of date totalizing and works as the time base of flow accumulation. It keeps operating as long as the battery's terminal voltage is over 1.5V. In case of battery failure, the time-keeper will not keep running and it will lose proper time values. The user must re-enter proper time values in case the battery becomes exhausted. An improper time value affects no other functions but the date totalizer.

§1.7 Product Identification

Each set of the Series flow meter has a unique product identification or ESN written into the software that can only be modified with special tool by the manufacturer. In case of any hardware failure, please provide this number which is located on menu window number M61 when contacting the manufacture.

§1.8 Specifications

Linearity	0.5%
Repeatability	0.2%
Accuracy	±1% of reading at rates>0.2 mps
Response Time	0-999 seconds, user-configurable
Velocity	±32 m/s
Pipe Size	20mm-6000mm
Rate Units	Meter, Feet, Cubic Meter, Liter, Cubic Feet, USA Gallon, Imperial Gallon, Oil Barrel, USA Liquid Barrel, Imperial Liquid Barrel, Million
Totalizer	7-digit totals for net, positive and negative flow
Liquid Types	Virtually all liquids
Security	Setup values Modification Lockout. Access code needs
Display	4x8 Chinese characters or 4x16 English letters
Communication Interface	RS-232C, baud-rate: from 75 to 57600. Protocol made by the manufacturer and compatible with that of the FUJI ultrasonic flow meter. User protocols can be made on
Transducers	Model M1 for standard, other 3 models for optional
Transducer Cord Length	Standard 2x10 meters, optional 2x 500 meters
Power Supply	3 AAA Ni-H built-in batteries. When fully recharged it will last over 10 hours of operation. 100V-240VAC for the charger
Data Logger	Built-in data logger can store over 2000 lines of data
Manual Totalizer	7-digit press-key-to-go totalizer for calibration
Housing Material	ABS
Case Size	100x66x20mm
Handset Weight	514g (1.2 lbs) with batteries

2. Starting Measurement

§2.1 Built-in Battery

The instrument can operate either from the built-in Ni-H rechargeable battery, which will last over 10 hours of continuous operation when fully charged, or from an external AC/power supply.

The battery charging circuits employ a scheme of constant-current and constant-voltage. It has a characteristic of fast charging at the beginning and very slow charging when the battery approaches to full recharge. Generally, when the green LED starts coming on, the battery would be nearly 95% recharged and when the red LED is off, the battery would be 98% recharged.

Since the charging current gets tapered when the battery recharge is nearly completed, i.e. the charging current becomes smaller and smaller, therefore, there should be no over-recharging problem. That means the charging progress can last very long. The charger can be connected to the handset all the time when an around-the-clock measurement is required.

When fully recharged, the terminal voltage reaches around 4.25V. The terminal voltage is displayed on window M07. When the battery is nearly consumed, the battery voltage drops to below 3V. The user can obtain an approximate battery working time from the battery voltage.

A software battery working time estimator is integrated in this instrument based on the terminal voltage. Please note that the estimator may have relatively bigger errors in the estimated working time, especially when the voltage is in the range of 3.70 to 3.90 volt.

§2.2 Power On

Press the ON key to switch on the instrument and press the OFF to turn off the power.

Once the flow meter is switched on, it will run self diagnostic program, checking the hardware then the software integrity. If there is any abnormality, corresponding error messages will be displayed.

Generally, there should be no display of error messages, and the flow meter will go to the most commonly used Menu Window Number 01 (M01) to display the Velocity, Flow Rate, Positive Totalizer, Signal Strength and Signal Quality, based on the pipe parameters configured last time by the user or by the initial program.

The flow measurement program always operates in the background of the user interface. This means the flow measurement will keep on running regardless of any user menu window browsing or viewing. Only when the user enters new pipe parameters will the flow meter change measurement to the new parameter changes.

When new pipe parameters have been entered or when the power has been just switched on, the flow meter will enter an adjusting mode to make the signals magnified with proper amplification. By this step, the flow meter is going to find the best threshold of receiving signal. The user will see the progress by the number 1, 2, or 3, which are indicated on the right lower corner of the LCD display.

When the transducers have been adjusted on the pipe by the user, the flow meter will re-adjust the signal automatically.

Any user-entered configuration value will be retained into the NVRAM of the flow meter, until it is modified by the user.

§2.3 Keypad

The keypad for the operation of the flow meter has 16+2 keys, as shown by below diagram.



Keys 0~9 and • are keys to enter numbers.

Key ▲ is the going UP key, when the user wants to go to the upper menu window. It also works as + key when entering numbers.

Key ▼ is the going DOWN key, when the user wants to go down-sided menu window. It also works as the - key when entering numbers.

Key ◀ is backspace key, when the user wants go left or wants backspace the left character that is located to the left of the cursor.

Key ENT is the ENTER key for any inputting or selections.

Key MENU is the key for the direct menu window jump over. Whenever the user wants to proceed to a certain menu window, the user can press this key followed by 2-digit numbers.

The MENU key is shortened as the 'M' key afterward when referring to the menu windows.

The ON key is for the power on.
The OFF key is for the power off.

§2.4 Menu Window

The user interface of this flow meter comprises 100 different menu windows that are numbered by M00, M01, M02 - M99.

There are 2 methods to enter certain menu window:

- (1) Direct going/entering. The user can press the MENU key followed by two-digit number keys. For example, the menu window M11 is for the entering of pipe outer diameter. The display will go to the M11 menu window after the user presses MENU and 11.
- (2) Pressing ▲ and ▼ keys. Each time of the ▼ key pressing will proceed to the lower-numbered menu window. For example, if the current window is on M12, the display will go to the number M11 window after pressing the ▼ key.

There are three different types of menu windows:

- Menu windows for number entering, like M11 for the entering of pipe outer diameter.
- Menu windows for option selection/selecting options, like M14 for the selection of pipe materials.
- Displaying windows only, like M00 to display Velocity, Flow Rate etc.

For number entering windows, the user can directly press the starting digit key when the user is going to modify the value. For example, when the current window is on M11, and the user is going to enter 219.2345 as the pipe outer diameter, the user can get the numbers entered by pressing the corresponding keys.

For the option selection windows, the user should first press the ENT key to a selection modification mode and then select the relevant options by pressing the ▲ and ▼ keys or the digit keys to select the option with a number antecedent to the option. In the end, the ENT key must be pressed to make the selection. For example, with menu window M14 for the selection of pipe material selection (the MENU, 1, 4 should be pressed first to enter this menu window if the current menu window is on a different window). The pipe material is stainless steel which has a number “1” antecedent to “stainless steel” on the display, the user should first press the ENT key to enter into a selection modification mode, then either make the selection by

pressing the ▼ and ▲ keys to make the cursor on the line that displays “1. Stainless Steel”, or make the selection by pressing the 1 key directly. Generally, the ENT key must be pressed to enter a modification mode. If the “Locked M47 Open” message is indicated on the lowest line of the LCD display, it means the modification operations is locked out. In such cases, the user should go to M47 to have the instrument unlocked first before any further modification can be made.

§2.5 Menu Windows Arrangement

M00~M09 windows for the display of the flow rate, velocity, date time, totalizer, battery voltage and estimated working hours for the battery.

M10~M29 windows for entering the pipe parameter.

M30~M38 windows for flow rate unit selections and totalizer unit selections.

M40~M49 windows for response time, zeroing, calibration and modification password setup. M50~M53 windows for the built-in logger

M60-M78 windows for time-keeper initialization, version and ESN information viewing and alarms. M82 window for viewing date totalizer.

M90~M94 are diagnostic windows for a more accurate measurement.

M97~M99 are not windows but commands for the outputting of display copying and pipe parameter setups. M+0~M+8 are windows for some additional functions, including a scientific calculator, viewer on records such as total working hours, turn-on and turn-off times, dates and times when the flow meter has been turned on or turned off.

Other menu windows such as M88 have no functions, or functions were cancelled because they are not applied to this version of the software. The major reason why the menu windows are arranged in this way is that the software programmer hopes that the menu window arrangement for this version has the highest compatibility with the previous versions of the flow meter software.

§2.6 Steps to Configure the Parameters

The following parameters need to be configured for a proper measurement:

- Pipe outer diameter
- Pipe wall thickness
- Pipe materials (for non-standard pipe materials*, the sound speed for the material must be configured too)
*Standard pipe materials and standard liquids refer to those with the sound parameters that have already been programmed into software of the flow meter, therefore there is no need to configure.
- Liner material and its sound speed and thickness, if there is any liner.
- Liquid type (for non-standard liquids, the sound speed of the liquid is also needed)
- Transducer type adapted to the flow meter. Generally the Standard M1 or the Frame M-sized transducers will be the selected option.
- Transducer mounting methods (the V-method or Z-method is the common option)
- Check up the Space displayed on M25 and install the transducers accordingly.

For standard pipe materials and standard liquids, the following detailed step-by-step setup is recommended.

1. Press keys MENU ,1, and 1 to enter M11 window to input the digits for the pipe outer diameter and then press ENTER key.
2. Press key ▼ to enter M12 window to input the digits for the pipe outer diameter and then press ENT key.
3. Press key ▼ to enter M14 window, and press ENT key to enter the option selection mode. Use keys to scroll up and down to the intended pipe material, and then press ENT key.
4. Enter M16 window, press ENT key to enter the option selection mode, use roll up and down to the liner material, and then press ENT key. Select “No Liner”, if there is no liner.
5. Enter M20 window, press ENTER key to enter the option selection mode, use keys ▲ and ▼ to scroll up and down to the proper liquid, and then press ENT key.
6. Enter M23 window, press key to enter the option selection mode, scroll up and down to the proper transducer type, and then press ENT key.
7. Enter M24 window, press ENTER key to enter the option selection mode, scroll up and down to the proper transducer mounting method.
8. Install the transducers on the pipe, and then press key to go to M01.

First-time users may need some time to get familiar with the operation. However, the user friendly interface of the instrument makes the operation quite easy and simple. The interface allows the user to go to the desired operation directly without any extra steps.





The following tips will facilitate the operation of this instrument.

1. When the window display is between M00 to M09, press a number key x , the user will go directly to the M0x window. For example, if the current window displays M01, press 7 and the user will go to M07.
2. When the window display is under M00 to M09, press the ENT key and the user will go to M90; press ENT key to return. Press the dot key to go to M11
When the window display is under M25, press ENT key to go to M01.

§2.7 Transducers Mounting Allocation

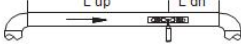
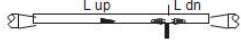
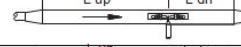
The first step in the installation process is the selection of an optimum location in order to obtain a more accurate measurement. For this to be completed effectively, a basic knowledge about the piping and its plumbing system would be advisable.

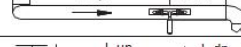
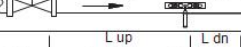
An optimum location would be defined as a straight pipe length full of liquid that is to be measured. The piping can be in vertical or horizontal position. The following table shows examples of optimum locations.

Piping Configuration and Transducer Position	Upstream Dimension	Downstream Dimension
	L up x Diameters	L dn x Diameters
	10D	5D
	10D	5D
	10D	5D
	12D	5D
	20D	5D
	20D	5D
	30D	5D

Principles to selection of an optimum location

1. Install the transducers on a longer length of the straight pipe. The longer the better, and make sure that the pipe is completely full of liquid.
2. Make sure that the temperature on the location does not exceed the range for the transducers. Generally speaking, the closer to the room temperature, the better.
3. Take the pipe fouling into consideration. Select a straight length of a relatively newer pipe. If the condition is not satisfying, consider the fouling thickness as part of the liner for a better result.
4. Some pipes have a kind of plastic liner, and between the outer pipe and the liner there may be a certain thickness difference that will prevent the ultrasonic waves from direct traveling. Such conditions will make the measurement very difficult. Whenever possible, try to avoid this kind of pipes. If impossible, try our plug-in transducers that are installed permanently on the pipe by drilling holes on the pipe while liquid is running inside.

§2.8 Transducers Installation

The transducers used by the series ultrasonic flow meter are made of piezoelectric crystals both for transmitting and receiving ultrasonic signals through the wall of liquid piping system. The measurement is realized by measuring the traveling time difference of the ultrasonic signals. Since the difference is very small, the spacing and the alignment of the transducers are critical factors to the accuracy of the measurement and the performance of the system. Meticulous care should be taken for the installation of the transducers.

Steps to the installation of the transducers

1. Locate an optimum position where the straight pipe length is sufficient, and where pipes are in a favorable condition, e.g., newer pipes with no rust and ease of operation.
2. Clean any dust and rust. For a better result, polishing the pipe with sander is strongly recommended.
3. Apply adequate coupler to the spot where the transducers are to be installed and leave no gap between the pipe surface and the transducers.

Extra care should be taken to avoid any sand or dust particles left between the pipe outer surface and the transducers.

To avoid gas bubbles inside the upper part of the pipe, the transducers should be installed horizontally by the side of the pipe.

§2.8.1 Transducers Spacing

The spacing value shown on menu window M25 refers to the distance of inner spacing between the two transducers. The actual transducers spacing should be as close as possible to the spacing value.

§2.8.2 V-method Installation

V-method installation is the most widely used mode for daily measurement with pipe inner diameters ranging from 20 millimeter to 300 millimeter. It is also called reflective mode or method.

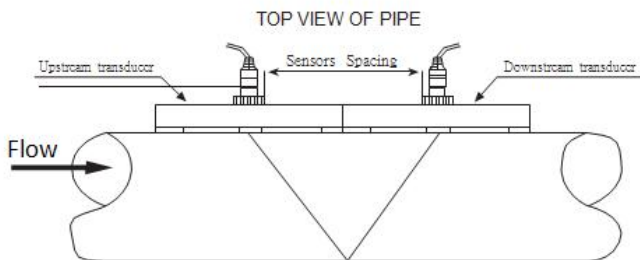

§2.8.3 Z-method Installation

Z-method is commonly used when the pipe diameter is between 300 millimeters and 500 millimeters.

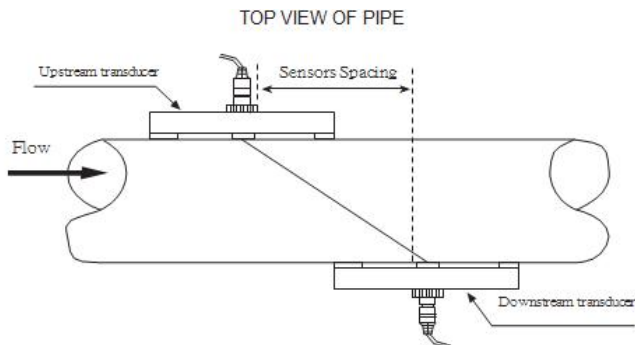

§ 2.8.4 W-method Installation

W-method is usually used on plastic pipes with a diameter from 10 millimeters to 100 millimeters.

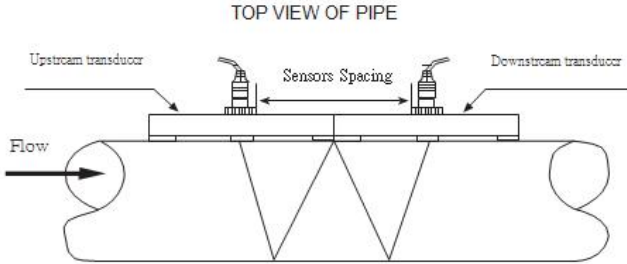

§2.8.5 N-method Installation

Rarely used method.

§2.9 Installation Checkup

Through the checkup of the installation, one can: check the receiving signal strength, the signal quality Q value, the traveling time difference of the signals, the estimated liquid speed, the measured traveling time of the signals and the calculated traveling time ratio. Therefore, optimum measurement result and longer running time of the instrument can be achieved.

§2.9.1 Signal Strength

Signal strength indicates the amplitude of receiving ultrasonic signals by a 3-digit number. [000] means there is no signal detected, and [999] refers to the maximum signal strength that can be received.

Although the instrument works well if the signal strength ranges from 500 to 999, stronger signal strength is desired, because stronger signal means better result. The following methods are recommended to obtain stronger signals:

1. Relocate a more favorable location, if the current location is not good enough for a stable and reliable flow reading, or if the signal strength is lower than 700.
2. Try to polish the outer surface of the pipe, and apply more coupler to increase the signal strength.
3. Adjust the transducers both vertically and horizontally while checking the varying signal strength, stop at the highest value, and then check the transducers spacing to make sure the transducers spacing is approximately what the M25 advises.

§2.9.2 Signal Quality

Signal quality is indicated as the Q value in the instrument. A higher Q value would mean a higher Signal and Noise Ratio (short for SNR), and accordingly a higher degree of accuracy would be achieved. Under normal pipe condition, the Q value is in the range 600-900, the higher the better.

Potential causes for a lower Q value:

1. Strong interference of other instruments and devices nearby. Try to relocate the flow meter to a new place where the interference can be reduced.
2. Bad sonic coupling for the transducers with the pipe. Try to apply more coupler or clean the surface.
3. Pipes are difficult to be measured. Relocation is recommended.

§2.9.3 Total Transit Time and Delta Time

The numbers displayed on menu window M93 are called total transit time and delta time respectively. They are the primitive data for the instrument to calculate the flow rate inside the pipe. So the flow rate indication will vary accordingly with the total time and delta time. The total transit time should remain stable or vary little.

If the delta time fluctuates higher than 20%, it means there are certain kinds of problems with the transducer installation.

§2.9.4 Time Ratio between the Measured Total Transit Time and the Calculated Time

This ratio would be used to check the transducer installation. If the pipe parameters are entered correctly and the transducers are installed properly, the value for this ratio should be in the range of 1003. If this range is exceeded, the user should check:

1. If the pipe parameters are correctly entered.
2. If the actual spacing of the transducers is right and the same as what the window M25 shows.
3. If the transducers are installed properly in the right directions.
4. If the mounting location is good and if the pipe has changed shape or if there is too much fouling inside the pipes
5. Other poor conditions.

3. How To

§3.1 How to judge if the instrument works properly

When 'R' is displayed in the lowest right corner of LCD display, the instrument is working properly, generally speaking.

If an 'H' flashes on that place, there could be poor signal received. Please refer to the chapters on diagnosis.

If an 'I' is displayed, it means that there is no signal detected.

If a 'J' is displayed, it means that the hardware of this instrument could be out of order. Refer to the chapter on diagnosis.

§3.2 How to judge the liquid flowing direction

1. Make sure that the instrument works properly
2. Check the flow rate for the indication. If the displayed value is POSITIVE, the direction of the flow will be from the RED transducers to the BLUE transducers; if the displayed value is NEGATIVE, the direction will be from the BLUE transducers to the RED transducers;

§3.3 How to change between units systems

Use menu window M30 for the selection of unit system in English or Metric system.

§3.4 How to select a required flow rate unit

Use menu window M31 to select the flow unit first and then the timing unit.

§3.5 How to use the totalizer multiplier

Use window M33 to select a proper totalizer. Make sure that the totalizer pulse is appropriately speeded. It should not be too fast and neither too slow. A speed of producing a pulse in several seconds or minutes is preferable.

If the totalizer multiplier is too small, there can be a loss of accumulation pulse because the output device can output only one pulse in measurement period (500milliseconds).

§3.6 How to open or shut the totalizer

Use M34, M35 and M36 to turn on or turn off the POS, NEG, or NET totalizer respectively.

§3.7 How to reset the totalizer

Use M37 to reset the proper totalizer.

§3.8 How to restore the flow meter with default setups

Use M37, when the 'selection' message is displayed. Press the dot key first and the message 'Master Erase' will display, then press the backspace key. The master erase step will erase all the parameters entered by the user and setup the instrument with default values.

§3.9 How to use the damper

The damper acts as a filter for a stable reading. If '0' is entered in window M40, that means there is no damping. A bigger number brings a more stable effect. But bigger damper numbers will prevent the instrument from response quickly.

Values 0 to 10 are commonly used for the damper value.

§3.10 How to use the zero-cutoff function

The number displayed in window M41 is called the low-cutoff value. The flow meter will replace these flow rate values that are absolutely less than the low-cutoff value with '0'. This means the flow meter will avoid any invalid accumulation when the actual flow is below the zero-cutoff value.

The low-cutoff value does not affect the flow measurement when the actual flow is absolutely greater than the low-cutoff value.

§3.11 How to setup a zero point

There exists a 'Zero Point' with certain installation which means the flow meter will display a non-zero value when the flow is absolutely stopped. In this case, setting a zero point with the function in window M42 will give more accurate measurement result.

Make sure that the flow is absolutely stopped, then run the function in window M42 by pressing the ENT key.

§3.12 How to get a scale factor for calibration

A scale factor is the ratio between the 'actual flow rate' and the indicated value by the flow meter. The scale factor can be determined by calibration with flow calibration equipment.

§3.13 How to use the operation locker

The system locker provides a means of preventing inadvertent configuration changes or totalizer resets.

When the system is locked, menu window browsing can be done without affecting any change, but any modifications are prohibited.

The system can be locked without a password or with a 1 to 4 digit password. With no-password locking, directly press the ENT key when the password input prompt displays.

If the password is forgotten, please contact the factory.

§3.14 How to use the built-in data logger

The data logger has a space of 24K bytes of memory, which will hold about 2000 lines of data. Use M50 to turn on the logger and for the selection for the items that is going to be logged.

Use M51 for the times when the logging begins and at how long an interval sustains and how long the data logging will last.

Use M52 for the direction of logging data. The default setting will permit the logging data to be stored in the logger buffer.

Logging data can be redirected to the RS-232C interface without being stored into the logger buffer. Use M53 to view the data in the logger buffer.

Dumping the logging data through the RS-232C interface and the clearing of the buffer can be operated with function in window M52.

§3.15 How to use the Frequency Output

There is a Frequency Output in all series flow meters. This frequency output signal, which represents the flow rate, is intended to connect with other instruments.

The Frequency Output is totally user-configurable. Generally, four parameters should be configured for the setups.

Enter the lower flow rate value in window M68 and the higher flow rate value in window M69. Enter the frequency range in window M67.

For example, assume that the flow rate varies in a range 0m³/h to 3000m³/h, and an output signal is at a maximum frequency of 1000Hz, the minimum of 200Hz is going to be required for other instrumentation. The user should enter 0 in M68 and 3000 in M69, and enter 200 and 1000 in window M67.

Please note that the user has to make the selection with OCT setups in window M78 by selecting the 13th option reading like 'FO output' to direct the frequency output to the OCT OUTPUT hardware device.

§3.16 How to use the Totalizer Pulse Output

The totalizer output will produce a pulse output with every unit flow of the totalizer. Refer §3.4 and §3.5 for the setups of the totalizer units and multiplier.

The totalizer pulse output can only be realized by mapping the pulse output to the OCT or BUZZER hardware devices.

For example, assume that the POS totalizer pulse output is needed, and every pulse should represent 0.1 cubic meter of liquid flow; the pulse output will be mapped to the internal Buzzer, so that with every 0.1 cubic meter of flow the BUZZER will beep for a while.

The following setups should be taken/performed:

1. Select the unit Cubic Meter under window M32.
2. Select the Multiplier as '2. X0.1' under window M33.
3. Select the output option '9. POS INT Pulse' under window M77. (INT stands for totalized)

§3.17 How to produce an alarm signal

There are 2 types of hardware alarm signals that are available with this instrument. One is the Buzzer, and the other is the OCT output.

Both for the Buzzer and OCT output the triggering sources of the event include the following:

1. Alarms on when there is no receiving signal
2. Alarms on when there is poor signal received.
3. Alarms on when the flow meter is not in normal measurement modes.
4. Alarms on reverse flow.
5. Alarms on the overflow of the Frequency Output
6. Alarms on when the flow is out of designated range set by the user.

There are two out-of-normal-range alarms in this instrument. They are called #1 Alarm and #2 Alarm. The flow range can be user-configurable through M73, M74, M75, M76.

For example, assume that the Buzzer should start beeping when the flow rate is less than 300 m³/h and greater than 2000m³/h, the following steps for setups would be recommended.

1. Enter 300 under M73 for #1 alarm low flow rate
2. Enter 2000 under M74 for #1 alarm high flow rate
3. Select the item reading like '6. Alarm #1' under M77.

§3.18 How to use the built-in Buzzer

The built-in buzzer is user-configurable. It can be used as an alarm. Use M77 for setups.

§3.19 How to use the OCT output

The OCT output is user-configurable, which can be performed by selecting the proper input source such as pulse output.

Use M78 for the setups.

Please make sure that the Frequency Output shares the OCT.

The OCT output shares pins with the RS-232C interface, and the terminal is at Pin 6 and the ground is at Pin 6.

§3.20 How to modify the built-in calendar

No modification on the built-in calendar will be needed in most cases. The calendar runs on insignificant amount of power supply. Modification will be required only in such cases as when the battery is totally consumed, or when the changing of the battery takes a long time.

Press the ENT key under M61 for Modification. Use the dot key to skip over these digits that need no modification.

§3.21 How to adjust the LCD contrast

Use M70 to the LCD contrast. The adjusted result will be stored in the EEPROM so that the MASTER ERASE will make no effect on the contrast.

§3.22 How to use the RS232 serial interface

Use M62 for the setup of the RS-232C serial interface.

§3.23 How to view the Date Totalizer

Use M82 to view the date totalizer that are comprised of a daily totalizer, a monthly totalizer and a yearly totalizer.

§3.24 How to use the Working Timer

Use the working timer to check the time that has passed with certain kind of operation.

For example, use it as a timer to show how long a fully-charged battery will last. Under M72, press ENT key and then select YES to reset the timer.

§3.25 How to use the manual totalizer

Use M28 for the manual totalizer. Press ENT key to start and stop the totalizer.

§3.26 How to check the ESN and other minor details

Every set of the series flow meter utilizes a unique ESN to identify the meter. The ESN is an 8-digit number that provides the information of version and manufacturing date. The user can also employ the ESN for instrumentation management. The ESN is displayed in window M61. Other details about the instrument are the total working hours displayed in window M+1, and the total power-on times displayed in window M+4.

§3.27 How to know how long the battery will last

Use M07 to check how long the battery will last. Also please refer to §.2.1

§3.28 How to charge the built-in battery

Refer to §2.1

Menu Window Details

Menu window No.	Function
M00	Display three positive negative net totalizers, signal strength, signal quality and working status
M01	Display POS totalizer, flow rate, velocity, signal strength, signal quality and working status
M02	Display NEG totalizer, flow rate, velocity, signal strength, signal quality and working status
M03	Display NET totalizer, flow rate, velocity, signal strength, signal quality and working status
M04	Display date and time, flow rate, signal strength, signal quality and working status
M05	Display date and time, velocity, signal strength, signal quality and working status
M06	Display the wave shape of the receiving signal
M07	Display the battery terminal voltage and its estimated lasting time
M08	Display the all the detailed working status, signal strength, signal quality
M09	Display today's total flow, velocity, signal strength, signal quality and working status
M10	Window for entering the outer perimeter of the pipe
M11	Window for entering the outer diameter of the pipe 0 to 6000mm is the allowed range of the value.
M12	Window for entering pipe wall thickness
M13	Window for entering the inner diameter of the pipe
M14	Window for selecting pipe material Standard pipe materials (that the user need not know the speed) include: (0) carbon steel (1) stainless steel (2) cast iron (3) ductile iron (4) copper (5) PVC (6) aluminum(7) asbestos(8) fiberglass
M15	Window for entering the pipe material speed only for non-standard pipe materials
M16	Window for selecting the liner material, select none for pipes without any liner Standard liner materials that the user need not know the speed include: (1) Tar Epoxy (2) Rubber (3) Mortar (4) Polypropylene (5) Polystyrol (6)Polystyrene (7) Polyester (8) Polyethylene (9) Ebonite (10) Teflon
M17	Window for entering the liner material speed only for non-standard liner materials
M18	Window for entering the liner thickness, if there is a liner
M19	Window for entering the ABS thickness of the inside wall of the pipe
M20	Window for selecting fluid type For standard liquids that the user need not know the liquid speed include: (0) Water (1) Sea Water (2) Kerosene (3) Gasoline (4) Fuel oil (5) Crude Oil (6) Propane at -45C (7) Butane at 0C (8)Other liquids (9) Diesel Oil (10)Caster Oil (11)Peanut Oil (12) #90 Gasoline (13) #93 Gasoline (14) Alcohol (15) Hot water at 125C

M21	Window for entering the fluid sonic velocity only for non-standard liquids
M22	Window for entering the viscosity of the non-standard liquids
M23	Window for selecting the proper transducers There are 14 different types of transducers for selection. If the user-type-transducers are used, 4 user type wedge parameters, which will be prompted by the software, should be entered following. If the π type transducers are used, 3 π type transducers and pipe parameters should be entered following.
M24	Window for selecting the transducer mounting methods Four methods can be selected: (0) V-method (1) Z-method (2) N-method (3) W-method
M25	Display the transducer mounting spacing
M26	Entry to store the parameter configuration into the internal NVRAM
M27	Entry to load one set of saved parameters
M28	Select YES or NO for the instrument to determine whether or not to hold (or to keep) the last correct value when poor signal condition occurs. YES is the default setup
M29	Enter a value ranging from 000 to 999. 0 is the default value
M30	Window for selecting unit system. Default value is 'Metric'. The change from English to Metric or vice versa will not affect the unit for totalizers.
M31	Window for selecting flow rate that will be used by the instrument afterward. Flow rate can be in Cubic meter short for (m3) Liter (l) USA gallon (gal) Imperial Gallon (igl) Million USA gallon (mgl) Cubic feet (cf) USA liquid barrel (bal) Imperial liquid barrel (ib) Oil barrel (ob) The flow unit in terms of time can be per day, per hour, per minute or per second. So there are 36 different flow rate units in total for selection.
M32	Window for selecting the totalizers' working unit
M33	Select totalizer multiplier The multiplier ranges from 0.001 to 10000
M34	Turn on or turn off the NET totalizer
M35	Turn on or turn off the POS totalizer
M36	Turn on or turn off the NEG totalizer
M37	Totalizer reset Restore the instrument to the default parameters as the manufacturer did

	by pressing the dot key followed by the backspace key. Take care or make note on the parameters before doing the restoration
M38	Press-a-key-to-run or to stop totalizer for easier calibration
M39	Operational interface language selection in Chinese and English. This selection makes it possible that more than 2 billions of people on the world can read the menu.
M40	Flow rate damper for a stable value. The input range is 0 to 999 seconds. 0 means there is no damping. Default value is 10 seconds
M41	Lower flow rate cut-off to avoid invalid accumulation.
M42	Zero point setup under the condition when there is no liquid running inside the pipe.
M43	Clear the zero point set by the user, and restore the zero point set by the manufacturer
M44	Set up a manual flow bias. Generally this value should be 0.
M45	Scale factor for the instrument. The default value is '1'. Keep this value as '1', when no user calibration has been made.
M46	Network environment Identification Number. Any integer can be entered except 13(ODH, carriage return), 10 (0AH, line feeding), 42 (2AH), 38, 65535. Every set of the instrument in a network environment should have a unique IDN. Please refer to the chapter for communication.
M47	System locker to avoid modification of the parameters
M48	Not used
M49	Communication tester
M50	"Option" selection for the built-in logger. It also functions as the switch of logger
M51	Time setup for the data logger
M52	Data logging direction control. If 'To RS-232' is selected, all the data produced by the data logger will be transmitted out through the RS-232 interface If 'To buffer ' is selected, the data will be stored into the built-in logger memory Buffer transferring and buffer clearing
M53	Logger buffer viewer. It functions as a file editor. Use Dot, backspace UP and DN keys to browse the buffer. If the logger is ON, the viewer will automatically refresh once new data are stored
M54	Not used
M55	Nod used
M56	Not used
M57	Not used
M58	Not used
M59	Not used
M60	99-year calendar. Press ENT for modification. Use the dot key to skip the digits that need no adjusting.

M61	Display Version information and Electronic Serial Number (ESN) that are unique for each series flow meter. The users can employ the ESN for instrumentation management
M62	RS-232 setup. Baud rate can be 75 to 115200 bps
M63	Not used
M64	Not used
M65	Not used
M66	Not used
M67	Input the frequency range for the frequency output. The biggest range is 0Hz-9999Hz. Default value is 1-1001 Hz
M68	Enter a flow rate value that corresponds to lower frequency
M69	Enter a flow Rate value that corresponds to higher frequency
M70	LCD display backlight control. The entered value indicates how many seconds the backlight will be on with every key pressing.
M71	LCD contrast control. The LCD will become darker when a small value is entered.
M72	Working timer. It can be cleared by pressing ENT key, and then select YES.
M73	Enter Lower Flow Rate value that will trigger the #1 Alarm. There are two virtual alarms in the system. By “virtual” we mean that the user must redirect the output of the alarms by setting up the output hardware in M78 and M77
M74	Enter the higher flow rate value that will trigger the #1 Alarm.
M75	Enter the lower flow rate value that will trigger the #2 Alarm.
M76	Enter the higher flow rate value that will trigger the #2 Alarm.
M77	Buzzer setup. If a proper input source is selected, the buzzer will beep when the trigger event occurs
M78	OCT (Open Collect Transistor Output) setup By selecting a proper input source, the OCT hardware will close when the trigger event occurs
M79	Not used
M80	Work as a keypad and display for another Handheld set by RS-232 connected with the handset
M81	Not used
M82	Date totalizer
M83	Not used
M84	Not used
M85	Not used
M86	Not used

M87	Not used
M88	Not used
M89	Not used
M90	Display signal strength, signal quality, time ratio on the upper right corner.
M91	Displays the Time Ratio between the Measured Total Transit Time and the Calculated time. If the pipe parameters are entered correctly and the transducers are properly installed, the ratio value should be in the range of $100\pm 3\%$. Otherwise the entered parameters and the transducer installation should be checked.
M92	Displays the estimated fluid sound velocity. If this value has an obvious difference with the actual fluid sound speed, pipe parameters entered and the transducer installation should be checked again.
M93	Displays total transit time and delta time(transit time difference)
M94	Displays the Reynolds number and the pipe factor used by the flow rate program.
M95	Not used
M96	Not used
M97	Command to record the pipe parameters entered by the user either to the built-in data logger or to RS-232C serial interface
M98	Command to record the diagnostic information either to the built-in data logger or to RS-232C serial interface
M99	Command to copy the current display either to the built-in data logger or to RS-232C serial interface
M+0	Browse the 64 recorded instrument power-on and power-off date and time with the flow rate at the time of power on and off
M+1	Displays the total working time of the instrument
M+2	Displays the last power-off date and time
M+3	Displays the last power-off flow rate
M+4	Displays the times of instrument powered on(the instrument has been powered on)
M+5	A scientific calculator for the convenience of field working. All the values are in single accuracy. The drawback is that the user can't operate it by direct key-pressing
M+6	Not used
M+7	Not used
M+8	Not used
M+9	Not used
M-0	Entry to hardware adjusting windows only for the manufacturer

5.Troubleshooting

§5.1 Power-on Error Displays and Counter-Measures

The series ultrasonic flow meter provides an automatic power-on diagnosis for the hardware problems. When any message (with the power on) in the following table displays, counter-measures should be taken.

Error message	causes	Counter-measures
ROM Testing Error Segment Test Error	Problem with the software	(1)Power on again (2)Contact with factory
Stored Data Error	The parameters entered by the user lose integration.	When this message displays, the user should press ENT key, and all the configuration will be restored to the
Timer Slow Error Timer Fast Error	Problem with the timer-keeper or the crystal oscillator.	(1)Power on again (2)Contact with factory
Date Time Error	Number errors with the	Initialize the calendar by menu window
Reboot repetitively	Hardware problems	Contact the factory

§5.2 Error Code and Counter-Measures

The series ultrasonic flow meter will show Error Code in the lower right corner with a single letter like I, R etc. on menu windows M00, M01, M02, M03, M90 and M08. When any abnormal Error Code shows, counter-measures should be taken.

Error code	Correspondent Message displayed on M08	Causes	Counter-measures
R	System Normal	No error	
!	Detect No Signal	(1)No Signals detected (2)Transducers installed improperly (3)Too much fouling (4)Pipe liners are too thick. (5)Transducer cords are not properly connected	(1)Relocate measuring location (2)Clean the spot (3)Check the cords
J	Hardware Error	Hardware problem	Contact the factory
H	Poor Sig Detected	(1)Poor signal detected (2) Transducers installed improperly (3)Too much fouling (4)The pipe liners are too thick. (5)Problem with transducers cords	(1)Relocate measuring place (2)Clean the spot (3)Check the cords (4)Check the coupler
Q	Freq. Output Over	The actual frequency for the Frequency Output is out of the range set by the user	Check the value entered at M66, M67, M68 and M69, and try to enter a larger value on M69
F	System RAM Error Date Time Error CPU or IRQ Error ROM Parity Error	(1)Temporary problems with RAM, RTC (2)Permanent problems with hardware	(1)power on again (2)contact factory
2 3	Adjusting Gain	Instrument is in the progress of adjusting the gain for the signal, and the number indicates the progressive steps	
K	Empty pipe	(1)No liquid inside pipe (2)Setup error on M29	(1)Relocate where the pipe is full of liquid (2)Enter 0 on M29

§5.3 Other Problems and Solutions

- When the actual flow inside the pipe is not standstill, but the instrument displays 0.0000 for the flow rate, and ‘R’ displaying signal strength and the signal quality Q (value) has a satisfactory value?

The problems are likely caused by the user who has used the ‘Set Zero’ function on this non- standstill flowing pipe. To solve this problem, use the ‘Reset Zero’ function on menu window M43.

- The displayed flow rate is much lower or much higher than the actual flow rate in the pipe under normal working conditions.
 - (1) There is probably an offset value wrongly entered by the user in M44. Enter ‘0’ in M44.
 - (2) Problem with transducer installation.
 - (3) There is a ‘Zero Point’. Try to ‘zero’ the instrument by using M42 and make sure that the flow inside the pipe should be still.
- The battery can not operate as long as the time period indicated in M07
 - (1) Battery should be replaced due to the end of the service life.
 - (2) Newly changed battery does not fit the battery estimating software. Customizing the battery with the software should be taken. Please contact the factory.
 - (3) The battery has not been fully recharged or the recharge has been stopped too many times halfway.
 - (4) There is indeed a time difference between the actual working time and the estimated one, especially when the terminal voltage is in the range 3.70 and 3.90 volt. Please refer to battery voltage for a closer estimated working time.

6. Communication Protocol

§6.0 General

This series ultrasonic flow meter integrates a standard RS-232C communication interface and complete set of communication protocols that are compatible with that of the Fuji's ultrasonic flow meter.

§6.1 Interface Pin-out Definition

Pin	1	For battery recharge, positive input
	2	RXD
	3	TXD
	4	Not used
	5	GND
	6	OCT output
	7	Not used
	8	For battery recharge, negative input
	9	RING input for connecting a MODEM

§6.2 Protocol

The protocol is comprised of set of basic commands that are strings in ASCII format, ending with a carriage (CR) and line feed (LF).

Commonly used commands are listed in the following table.

Command	Function	Data Format
DQD(CR)	Return flow rate per day	±d.dddddE±dd(CR)(LF)*
DQH(CR)	Return flow rate per hour	±d.dddddE±dd(CR)(LF)
DQM(CR)	Return flow rate per minute	±d.dddddE±dd(CR)(LF)
DQS(CR)	Return flow rate per second	±d.dddddE±dd(CR)(LF)
DV(CR)	Return flow velocity	±d.dddddE±dd(CR)(LF)
DI+(CR)	Return POS totalizer	±ddddddE±d(CR)(LF)**
DI-(CR)	Return NEG totalizer	±ddddddE±d(CR)(LF)
DIN(CR)	Return NET totalizer	±ddddddE±d(CR)(LF)
DID(CR)	Return Identification Number	dddd (CR) (LF)
DL(CR)	Return signal strength and quality	S-dd,dddQ-dd(CR)(LF)
DT(CR)	Return date and time	yy-mm-dd hh:mm:ss(CR) (LF)
M@(CR)***	Send a key value as if a key is pressed	
LCD(CR)	Return the current window display	

FOdddd(CR)	Force the FO output with frequency in dddd Hz	
ESN(CR)	Return the ESN for the instrument	Dddddddd(CR)(LF)
RING(CR)	Handshaking Request by a MODEM	
OK(CR)	Response from a MODEM	No action
GA	Command for GSM messaging	Please contact factory for detail
GB	Command for GSM messaging	
GC	Command for GSM messaging	
DUMP(CR)	Return the buffer content	In ASCII string format
DUMP0(CR)	Clear the whole buffer	In ASCII string format
DUMP1(CR)	Return the whole buffer content	In ASCII string Format, 24KB in length
W	Prefix before an Identification Number in a network environment. The IDN is a word, ranging 0-65534.	
N	Prefix before an Identification Number in a network environment. The IDN is a single byte value, ranging 00-255.	
P	Prefix before any command	
&	Command connector to make a longer command by combining up to 6 commands	

Notes

*CR stands for Carriage Return and LF for Line Feed.

** 'd' stands for the 0~9 digit numbers.

*** @ stands for the key value, e.g., 30H for the '0' key.

§6.3 Protocol Prefix Usage

➤ Prefix P

The prefix P can be added before any command in the above table to have the returning data followed with two bytes of CRC check sum, which is the adding sum of the original character string.

Take the DI+(CR) command as an example. Assume that DI+(CR) would return +1234567E+0m3 (CR)(LF)(the string in hexadecimal is 2BH, 31H, 32H, 33H, 34H, 35H, 36H, 37H, 45H, 2BH, 30H, 6DH, 33H, 20H, 0DH, 0AH) , then PDI(CR) would return +1234567E+0m3!F7(CR)(LF).

‘!’ acts as the starter of check sum which is yielded by adding up the string 2BH, 31H, 32H, 33H, 34H, 35H, 36H, 37H, 45H, 2BH, 30H, 6DH, 33H, 20H.

Please note that there will be SPACES (20H) before ‘!’.

➤ Prefix W

The prefix W should be used in the network environment. The usage format is W + digit string which stands for the IDN + basic command. The digit string should have value between 0 and 65534 except 13(0DH), 10 (0AH), 42(2AH,*), 38(26H, &).

For example, if the IDN — 12345 instrument is addressed and returning the velocity of that instrument is requested, the command will be W12345DV(CR).

➤ Prefix N

The prefix N is a single byte IDN network prefix, not recommended in a new design. It is reserved only for the purpose of the compatibility with the former versions

➤ Command Connector &

The & command connector can connect up to 6 basic commands to form a longer command so that it will make the programming much easier.

For example, assume that the measurement of an instrument with IDN —4321 are going to be returned, and (then) all the following 3 values---

(1) flow rate (2) velocity (3)POS totalizer---will be returned simultaneously. The combined command would be

W4321DQD&DV&DI+(CR), and the result would be:

+1.234567E+12m3/d(CR)

+3.1235926E+00m/s(CR)

+1234567E+0m3(CR)

§6.4 Codes for the Keypad

The codes for the keypad should be used when the instrument is connected with other terminals that operate the instrument by transmitting the 'M' command along with the keypad code. By this function, remote operation of this instrument can be realized, even via the Internet.

Key	Hexadecimal Key code	Decimal Key	ASCII Code	Key	Hexadecimal Key code	Decimal Key code	ASCII Code
0	30H	48	0	8	38H	56	8
1	31H	49	1	9	39H	57	9
2	32H	50	2	—	3AH	58	:
3	33H	51	3	⏏	3BH,0BH	59	;
4	34H	52	4	MENU	3CH,0CH	60	<
5	35H	53	5	NET	3DH,0DH	61	-
6	36H	54	6	⏏/+	3EH	62	>
7	37H	55	7		3FH	63	?

7. Warranty and Service

§7.1 Warranty

The manufacturer provides one year warranty on all products, free of charge, but the users should be responsible for the one-way transportation fee from the customer to the factory.

§7.2 Service

The manufacturer provides instrument installation for our customers, and the charges will be made according the cost.

For any hardware failure of the instrument, we recommend that our customers send back the instrument to our factory for service, due to the fact that the instrument is made of microprocessors and it will be difficult to perform field maintenance. Before sending back the instrument, please try to contact the factory first to identify the issue.

For other operational problems, please contact our service department by telephone, fax or email.

In most cases, the problem could be solved immediately.